



User Manual

VERSION 1.06

AIT1000 Class B AIS Transponder

Part Number ZDIGAIT1000



General Warnings

All marine Automatic Identification System (AIS) units utilise a satellite based system such as the Global Positioning Satellite (GPS) network or the Global Navigation Satellite System (GLONASS) network to determine position.

The accuracy of these networks is variable and is affected by factors such as the antenna positioning, how many satellites are used to determine a position and how long satellite information has been received for.

It is desirable wherever possible therefore to verify both your vessels AIS derived position data and other vessels AIS derived position data with visual or radar based observations.

The compass safe distance of this unit is 0.5m or greater for 0.3° deviation.

In accordance with a policy of continual development and product improvement the AIT1000 hardware and software may be upgraded from time to time and future versions of the AIT1000 may therefore not correspond exactly with this manual.

When necessary upgrades to the product will be accompanied by updates or addenda to this manual.

Please take time to read this manual carefully and to understand its contents fully so that you can install and operate your AIS system correctly.

Information contained in this manual is liable to change without notice.

FCC Compliance

Use of this equipment on US Flagged vessels is currently not authorised as Class B AIS has yet to be approved by the USCG

This equipment has been tested and found to comply with the limits for a Class B digital device, pursuant to part 15 of the FCC Rules. These limits are designed to provide reasonable protection against harmful interference in a residential installation. This equipment generates, uses and can radiate radio frequency energy and, if not installed and used in accordance with the instructions, may cause harmful interference to radio communications. However, there is no guarantee that interference will not occur in a particular installation. If this equipment does cause harmful interference to radio or television reception, which can be determined by turning the equipment off and on, the user is encouraged to try to correct the interference by one or more of the following measures:

- Reorient or relocate the receiving antenna.
- Increase the separation between the equipment and receiver.
- Connect the equipment into an outlet on a circuit different from that to which the receiver is connected.
- Consult the dealer or an experienced radio/TV technician for help.

The AIT1000 does not contain any user serviceable parts. Repairs should only be made by an authorized Digital Yacht service agent. Unauthorised repairs or modifications could result in permanent damage to the equipment and void your warranty and you're authority to operate this equipment under Part 15 regulations.

RF Emissions Notice

Caution: The AIT1000 Class B AIS transponder generates and radiates radio frequency electromagnetic energy. This equipment must be installed and operated according to the instructions contained in this handbook. Failure to do so can result in personal injury and / or product malfunction.

Caution: Never operate the transponder unless it is connected to a VHF antenna.

To maximise performance and minimise human exposure to radio frequency electromagnetic energy you must make sure that the antenna is mounted at least 1.5 meters away from the transponder and is connected to the transponder before power is applied.

The system has a Maximum Permissible Exposure (MPE) radius of 1.5m. This has been determined assuming the maximum power of the transponder and using antennas with a maximum gain of 3dBi.

- The antenna should be mounted as high above the deck as possible.
- Higher gain VHF antennas will require a greater MPE radius.
- Do not operate the unit when anyone is within the MPE radius of the antenna (unless they are shielded from the antenna field by a grounded metallic barrier).
- The antenna should not be collocated or operated in conjunction with any other transmitting antenna.

This device has been designed to operate with the supplied antenna or any standard marine VHF antennas having a maximum gain of 3dBi. Antennas not included in this list or having a gain greater than 3dBi are strictly prohibited for use with this device. The required antenna impedance is 50 ohms.

Licensing and Maritime Mobile Service Identity (MMSI)

IMPORTANT: In most countries the operation of an AIS unit is included under the vessel's marine VHF licence provisions. The vessel on to which the AIS unit is to be installed must therefore possess a current VHF radiotelephone licence which lists the AIS system and the vessel Call Sign and MMSI number.

An MMSI number is required in order for the AIT1000 transponder to operate.

Please contact the relevant authority in your country for more information.

Product Specification

Parameter	Value
Dimensions	250 x 155 x 37.5 mm (L x W x H)
Weight	1450g
Power	DC (10.8 - 15.6V) Average power consumption 4W Peak current rating 2A
GPS Receiver (AIS Internal)	IEC 61108-1 compliant
Electrical Interfaces	USB 38.4k Baud bi-directional RS422 NMEA 38.4k Baud bi-directional
Connectors	VHF antenna connector GPS antenna connector USB (type A) Connector NMEA In/NMEA Out/External Switch/Power cable
VHF Transceiver	Transmitter x 1 Receiver x 2 (One receiver time shared between AIS and DSC) Frequency: 156.025 to 162.025 MHz in 25 kHz steps
Output Power	33dBm \pm 1.5 dB
Channel Bandwidth	25kHz
Channel Step	25kHz
Modulation Modes	25kHz GMSK (AIS, TX and RX) 25kHz AFSK (DSC, RX only)
Bit rate	9600 b/s \pm 50 ppm (GMSK) 1200 b/s \pm 30 ppm (FSK)
RX Sensitivity	Sensitivity - 107dBm 25kHz (Message Error Rate 20%) Co-channel 10dB Adjacent channel 70dB IMD 65dB Blocking 84dB
Environmental	IEC 60945 Operating temperature: -25°C to +55°C IEC 62287, Section 5, Cat (c) exposed to the weather
Indicators	Power, TX timeout, status, pre-set SRM sent.
Operator Controls	Optional pre-set safety related message (SRM) transmit button

Standards

This product complies to all the necessary standards under the European R&TTE directive for Article 3.1(a), 3.1(b), 3.2 and

3.3(e). The following standards have been followed in pursuance of this:

- IEC62287-1: 2006-03 Maritime navigation and radiocommunication equipment and systems – Class B shipborne equipment of the automatic identification system (AIS) – Part 1: Carrier-sense time division multiple access (CSTDMA) techniques
- IEC60945: 2002-08 Maritime navigation and radiocommunication equipment and systems – General requirements – Methods of testing and required test results
- IEC61162-1: Maritime navigation and radiocommunication equipment and systems – Digital interfaces – Part 1: Single talker and multiple listeners
- IEC61108-1: GLOBAL NAVIGATION SATELLITE SYSTEMS (GNSS) – Part 1: Global positioning system (GPS) - Receiver equipment - Performance standards, methods of testing and required test results
- EN 301 843-1 v2.1: Electromagnetic compatibility and Radio spectrum Matters (ERM); Electromagnetic Compatibility (EMC) standard for marine radio equipment and services; Part 1: Common technical requirements
- EN 50383: 2002 Basic standard for calculation and measurement of electromagnetic field strength and SAR related to human exposure from radio base stations and fixed terminal stations for wireless telecommunications system (110MHz – 40GHz)
- EN60950-1:2002 Information technology equipment – Safety – Part 1: General requirements

Declaration of Conformity

Digital Yacht declares that this product is in compliance with the essential requirements and other provisions of the R&TTE directive 1999/5/EC.

The product carries the CE mark, notified body number and alert symbol as required by the R&TTE directive

The product is intended for sale in the following member states:

Intended Country of Use:			
<input type="checkbox"/> GB	<input type="checkbox"/> FR	<input type="checkbox"/> ES	<input type="checkbox"/> SE
<input type="checkbox"/> AT	<input type="checkbox"/> NL	<input type="checkbox"/> PT	<input type="checkbox"/> DK
<input type="checkbox"/> NO	<input type="checkbox"/> BE	<input type="checkbox"/> IT	<input type="checkbox"/> FI
<input type="checkbox"/> IE	<input type="checkbox"/> LU	<input type="checkbox"/> GR	<input type="checkbox"/> CH

Introduction

How AIS Works

The marine Automatic Identification System (AIS) is a location and vessel information reporting system. It allows vessels equipped with AIS to automatically and dynamically share and regularly update their position, speed, course and other information such as vessel identity with similarly equipped craft. Position is derived from the GPS network and communication between vessels is by Very High Frequency (VHF) digital transmissions. A sophisticated and automatic method of time sharing the radio channel is used to ensure that even where a large number of vessels are in one location blocking of individual transmissions is minimised, any degradation of the expected position reporting interval is indicated to the user and even if the unit suffers extreme channel overload conditions it will always recover to normal operation.

AIS Classes

There are two classes of AIS unit fitted to vessels, Class A and Class B. In addition AIS base stations may be employed by the Coastguard, port authorities and other authorised bodies. AIS units acting as aids to navigation (A to Ns) can also be fitted to fixed and floating navigation markers such as channel markers and buoys.

Class A units are a mandatory fit under the safety of life at sea (SOLAS) convention to vessels above 300 gross tons or which carry more than 11 passengers in International waters. Many other commercial vessels and some leisure craft also fit Class A units.

Class B units are currently not a mandatory fit but authorities in several parts of the world are considering this. Class B units are designed for fitting in vessels which do not fall into the mandatory Class A fit category.

The AIT1000 is a Class B unit

Position Information Source

As noted above the marine AIS system uses position information derived from networks such as the Global Positioning Satellite (GPS) or the Global Navigation Satellite System (GLONASS) in order to determine the location of the AIS unit and thus the vessel to which it is fitted.

The AIT1000 utilises the GPS satellite network.

Installing the AIT1000 unit

- WARNING:** Do not connect the AIT1000 unit to a mains (line) AC electrical supply, as an electric shock or fire hazard could result.
- CAUTION:** Do not connect the AIT1000 unit to a DC supply exceeding 15.6 V or reverse the supply polarity. Damage to the unit may result.
- CAUTION:** The AIT1000 unit is designed for operation in the temperature range -25 °C to +55 °C. Do not install (or use) the AIT1000 unit in environments which exceed this range.
- CAUTION:** Do not install the AIT1000 unit in an environment where it can be subject to excessive exposure to water.

Electrical connections

Warning: Only the RF, data and power cables provided with the AIT1000 unit should be used to connect antennas, power and display devices so as to maintain the integrity of the enclosure.

Please see the drawings section of this manual for details of the power/data and RF cables supplied.

Using the two co-axial connectors on the front of the AIT1000, connect the down-lead from a VHF antenna to the "BNC - VHF ANT" connector and connect the down-lead of the supplied GPS antenna to the "TNC - GPS ANT" Connector. Please refer to the later "Antennas Section" of this User Manual for recommendations on antennas and antenna installation.

If an external dedicated chart plotter is to be used as the AIS display unit (NMEA 0183 interface) connect the relevant wires of the AIT1000 "PWR/DATA" interface cable to the chart plotters NMEA ports. Note that the software in the chart plotter must be configured for AIS operation AND to accept standard Class B operation NMEA sentences.

If an external display unit is not to be used, terminate and insulate the unused NMEA connections on the AIT1000 "PWR/DATA" cable.

Connect a 12V DC supply (9.6-15.6V) capable of supplying 2A peak to the AIT1000 "PWR/DATA" cable (Red = Positive and Black = negative).

The case of the unit is not isolated from the negative terminal of the supply and therefore it is recommended that the unit is not attached to metal parts of the vessel. Special arrangements will need to be made on steel and aluminium vessels to isolate the case from the hull.

For a full step by step guide to installing the AIT1000, please refer to the printed Quick Start Guide included in the AIT1000 product package.

Programming the transponder

Programming software

Before the AIT1000 can be used it requires 'personalisation'.

This is done via the AIT1000 proAIS software package which is supplied on the "AIS Resource" CD-ROM. The proAIS user guide contains more detail on configuration of the transponder (included at the end of this handbook)

This software is designed to be installed on a PC and to use the USB lead provided as standard with the AIT1000 unit.

Configuration

The AIT1000 personalisation data required is the ship's MMSI, the ship's name, its dimensions, position reference, type and call sign. Please refer to the proAIS user guide for more information on configuration and installation diagnostics.

Using the transponder

Switching on

Under normal operation (after the AIT1000 has been "personalised"), when the 12V supply is switched on all four LEDs visible on the front panel of the unit will illuminate twice for a period of one second on each illumination. The red and blue LEDs will then go out. When the internal GPS starts outputting valid position information and the AIT1000 unit transmits its first position report (message 18) the yellow LED will go out; note that this process may take up to 30-60 seconds from the GPS receiving its first valid position fix. When the yellow LED goes out the green LED will illuminate indicating that the unit is now operating correctly.



Switch functions

The AIT1000 has a remote switch feature that can be configured **either** to trigger transmission of a "Safety Related Message" or to place the unit into "Silent mode". This choice is made during configuration of the unit using the proAIS application; please refer to the proAIS user guide for further information on the configuration options.

When configured to transmit a "Safety Related Message" the button will initiate broadcast of an AIS message containing the vessels MMSI along with the text "MAYDAY MAYDAY". The button must be pressed for at least two seconds to initiate this transmission and the blue LED will illuminate to indicate the message has been sent. Additional "Safety Related Messages" can not be sent until the blue LED has extinguished which will occur one minute after an SRM has been sent.

When configured to place the unit into "Silent mode" each press of the switch will toggle the AIS transmitter on or off. The switch must be depressed for two seconds to change the state of the transmitter. When the transmitter is off, the yellow "TX Timeout" LED and blue "Silent" LEDs will be illuminated and the transponders position will not be broadcast to other vessels. The position of other vessels will still be received by the unit.

Warning and fault states

If the unit has not been able to transmit a position report during the last expected two reporting intervals (i.e. the nominal reporting interval cannot be maintained for operational reasons such as a Message 23 quiet period, high channel load conditions, etc) the yellow LED will illuminate. This is a warning condition only and indicates that your vessels position is not currently being reported to other vessels. Reception of other vessel AIS information by the AIT1000 is not affected. When the unit is able to commence reporting the yellow LED goes out.

If a fault occurs the red LED will illuminate. This may illuminate briefly if the power supply is interrupted or if the VHF antenna characteristics are briefly affected.

If the Red LED illuminates continuously the unit should be assumed to be faulty and should either be switched off (power removed) or if this is not practical any other vessel position information derived from the unit should not be used and it should also be assumed that the unit is not transmitting valid position information for your vessel.

The unit should be examined by a competent Digital Yacht approved equipment maintainer at the earliest opportunity.

Data port messages

The data port will output the following:

- (At power-up) boot-loader and main application splash text screens including version numbers, and memory status
- Details of relevant AIS transmissions received
- Details of AIS transmissions sent
- Details of channel management messages received
- Alarm messages generated by the BIIT function

The data port will accept the following inputs:

- Programming information
- Alarm acknowledgements

Please see the 'Data Interface' section of this manual for more details of the data port messages.

When in operation an AIS unit:

- Uses one of two VHF channels within the international marine band allocation (channel 87B; 161.975MHz, or channel 88B; 162.025MHz) to regularly transmit information such as the vessel position, Maritime Mobile Service Identity (MMSI), name, speed, course, etc.
- Receives similar information from other AIS equipped vessels within VHF range and outputs that information for use by an external display medium (AIS enabled chart plotter, PC using AIS enabled chart plotter software etc.)

Information Transmitted and Received

A Class A unit will transmit its IMO number (if known), MMSI, Call sign and Name, length and beam, ship type, time, course over ground (COG), speed over ground (SOG), heading, navigational status, rate of turn, draught, cargo type, destination and safety related messages via a short message service (SMS) facility. Message lengths are variable with static and voyage related information being transmitted less often.

A Class B unit will transmit its MMSI, Call Sign and Name, length and beam, ship type, time, course over ground (COG), speed over ground (SOG) and heading.

Built In Test

The AIT1000 unit is equipped with Built In Integrity Testing (BIIT). BIIT tests run continuously or at appropriate intervals simultaneously with the standard functions of the equipment. The BIIT detects any failure or malfunction that will significantly reduce integrity or stop operation of the AIT1000 unit.

The tests include:

- AIS TX malfunction (synthesiser not locked and TX time-out not exceeded)
- Antenna VSWR exceeds limit
- Rx channel 1 malfunction (synthesiser not locked)
- Rx channel 2 malfunction (synthesiser not locked)
- Internal GPS not in use
- No valid SOG information
- No valid COG information
- Background noise > -77dBm
- GPS failure

- VSWR exceeding the maximum allowed level
- The input voltage is out of the specified range

LED Indicators

Power

This is a green LED which indicates, when lit, that power has been connected correctly to the transponder, that the transponder hardware has been configured, that the operating software is present, that the CPU has booted up, the application software is running.

TX Timeout

This is a yellow LED which indicates when lit that the CSTDMA transmitter is prevented from transmitting. Reasons for this include the following:

- The transponder's internal GPS receiver is not operating or is not yet ready. [1] requires that a class B CSTMA transponder shall not transmit if its internal position sensor is not operating
- The transponder was unable to transmit an AIS message due to the channel being already occupied, e.g. by transmissions from other AIS transponders
- The transponder is in "Silent mode"

Status

This is a red LED which indicates, when lit, one of the following status conditions is possible:

- Transmitter lockout timer (1 second maximum) has operated
- GPS is unable to gain lock after 30 minutes
- VHF antenna VSWR is out of range
- Power supply is out of range
- Background noise level is above the threshold level (-77dBm)

Silent

This is a blue LED which **either** indicates that a Safety Related Message has been transmitted **or** that the unit is in "Silent mode". The condition indicated by the blue LED is determined during configuration of the unit by the switch option selected. Please refer to the "Switch functions" section of this manual for more detail.

- Transmission of a Safety Related Message is indicated by both the green and blue LEDs being illuminated

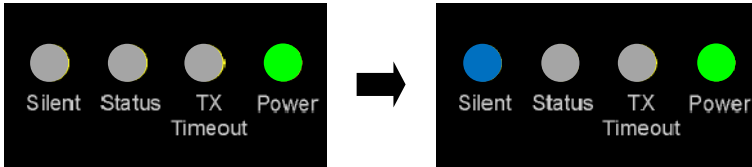

- Silent mode is indicated by both the yellow and blue LEDs being illuminated.

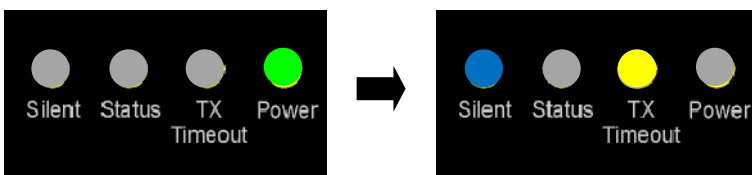

Antennas

The AIT1000 unit requires VHF and GPS antennae independent from those in use for other purposes. Please see Appendix A for details of the antennae required and supplied as standard with the unit

Maintenance

- WARNING:** Unauthorised opening of the AIT1000 system will invalidate the warranty.
- CAUTION:** Avoid using chemical solvents to clean the AIT1000 as some solvents can damage the case material.
- NOTE:** The AIT1000 contains no user serviceable parts. Contact your Service Agent for repair if replacing the fuse fails to make the equipment serviceable.

Serial Data Interface

Power Connection / Data Connection

There is an 8 Core Power/Data Cable and a USB Cable that extend from the two glands on the bottom end of the AIT1000 housing. These two cables are approximately 0.75m long.

Power

12V DC (9.6-15.6V) is connected to the AIT100 transponder via the Red(+) and Black(-) wires in the 8 Core Power/Data Cable.

Data

A minimum keypad and display (MKD) unit, chart plotter or other display device may be connected to the AIT1000 OEM unit via the NMEA Output wires in the AIT1000 Power/Data cable. The default baud rate of the data link is 38.4kBaude with 8 data bits, one stop bit and no parity. No handshaking is used.

The data interface conforms to IEC 61162-1.

VDM, VDO, ACA, ACS, ALR, TXT and ACK messages conform to NMEA 0183. Please refer to the International NMEA 0183 Standard for full details of these AIS messages.

Serial Port and USB Port Input/Output

The AIT1000 has two communication ports; one NMEA 0183 and the other USB. Data can be input from either or both ports.

The two communication port interface(s) output:

- At power-up boot-loader and main application splash text screens including version numbers and memory status.
- As a VHF Data Link Message (VDM) all incoming VHF Data Link (VDL) data received by the AIT1000.
- The VHF data link own vessel (VDO) messages sent by the AIT1000 over the VHF Data Link.
- AIS regional channel assignment messages (ACA) received. These are derived from an incoming VHF Data Link message (message 22) or a DSC message.
- AIS channel management information source (ACS) messages.
- Alarm messages (ALR, TXT).

The data interface will accept:

- Personality programming messages
- Alarm acknowledgement messages (ACK)

Power up messages

On power up the unit will report details of the firmware versions residing in the unit.

VHF data link messages (NMEA 0183 VDM)

Receipt of a VHF Data Link (VDL) message on either AIS radio channel causes a VDM message to be output on both communication ports (NMEA and USB). Please see IEC 61193-2, Annex B for a list of messages.

VDM Message Format

```
!--VDM,x1,x2,x3,a,s--s,x*hh<CR><LF>
```

Where:

- x1 = Total number of sentences needed to transfer the message , 1 to 9
- x2 = Sentence number, 1 to 9
- x3 = Sequential message identifier, 0 to 9
- a = AIS Channel, "A" or "B"
- s - - s = Encapsulated ITU-R M.1371 radio message
- x = Number of fill-bits , 0 to 5

VDM Message Types

For example, the information contained in the s - - s portion of the VDM = Encapsulated ITU-R M.1371 radio message. Note that messages 5 and 19 may be sent as multi part messages using the x1, x2 and x3 parameters for message sequence control.

VDL Message number	VDM Message description
AIS Target Display Information	
1, 2, 3, 9,18, 21	position report
4	base station report
5*	voyage related data
19*	Class B – extended data
Safety message handling	
12	addressed safety related
14	broadcast safety related
External Application handling	
6	binary addressed
8	binary broadcast
System control	
7	binary acknowledge (INFO)
10	UTC and data inquiry (INFO)
11	UTC and data response (INFO)
13	safety related ack (INFO)

VDL Message number	VDM Message description
15	interrogation (INFO)
16	assignment mode command (INFO)
17	DGNSS corrections (INFO)
20	data link management (INFO)
22	channel management (INFO)

*Note that messages 5 and 19 may be sent as multi part messages.

VHF data link own vessel messages (NMEA 0183 VDO)

This message describes the own vessel message being sent.

VDO Message Format

```
!-VDO,x1,x2,x3,a,s--s,x*hh<CR><LF>
```

Where

- x1 = Total number of sentences needed to transfer the message , 1 to 9
- x2 = Sentence number, 1 to 9
- x3 = Sequential message identifier, 0 to 9
- a = AIS Channel, "A" or "B"
- s - - s = Encapsulated ITU-R M.1371 radio message 4
- x = Number of fill-bits , 0 to 5

VDO Message number	VDO Message description
AIS Target Display Information	
13	Safety Related Acknowledgement
18	Standard Class B position report (Includes MMSI, SOG, position accuracy, lat, long, COG, true heading,)
24a	Class B "CS" Static data Part A (Includes MMSI and vessel name)
24b	Class B "CS" Static data Part B (MMSI, ship type, cargo type, call sign, ship dimensions)

Regional Assignment Channel Assignment Message (NMEA 0183 ACA)

An AIT1000 unit can receive regional channel management information in two ways: ITU-R M.1371 message 22 or a DSC telecommand received on channel 70,

ACA Message Format

```
$--ACA,x,IIII.II,a,yyyyy.yy,a,IIII.II,a1,y1y1y1y1y.y1y1,a2,x1,x2x2x2x2,x3,x4x4x4x4,x5,x6,x7,a3,x8,hhmmss.ss*hh<CR><LF>
```

Where

- x = Sequence Number , 0 to 9
- IIII, II, a = Region Northeast corner latitude – N/S

- yyyy.yy,a1 = Region Northeast corner longitude – E/W
- llll.ll,a = Region Southwest corner latitude – N/S
- y1y1y1y1y1.y1y1,a2 = Region Southwest corner longitude – E/W
- x1 = Transition Zone Size
- x2x2x2x2 = Channel A
- x3 = Channel A bandwidth
- x4x4x4x4 = Channel B
- x5 = Channel B bandwidth
- x6 = Tx/Rx mode control
- x7 = Power level control
- a3 = Information source
- x8 = In-Use Flag
- hhmmss.ss = Time of "in-use" change

Channel management information source messages (NMEA 0183 ACS)

This sentence is used in conjunction with the ACA sentence and identifies the originator of an ACA message.

ACS Message Format

```
$--ACS,x,xxxxxxxx, hhmmss.ss,xx,xx,xxxx*hh <CR><LF>
```

- x = Sequence Number , 0 to 9
- xxxxxxxx =MMSI of originator
- hhmmss.ss = UTC of receipt of channel management information
- xx = UTC Day, 01 -31
- xx = UTC Month, 01 -12
- xxxx = UTC Year

AIS Alarm Messages (NMEA 0183 ALR, Text)

ALR message format

```
$--ALR,hhmmss.ss,xxx,A,A,c--c*hh<CR><LF>
```

Where

- hhmmss.ss = Time of alarm (UTC)
- xxx = Unique alarm number
- A = Alarm condition
- A = Alarm acknowledge state
- c--c = alarm description, text

Alarms descriptions presented are:

- AIS: TX malfunction
- AIS: Antenna VSWR exceeds limit

- AIS: Rx channel 1 malfunction
- AIS: Rx channel 2 malfunction
- AIS: general failure
- AIS: no sensor position in use
- AIS: no valid SOG information
- AIS: no valid COG information
- AIS: 12V alarm
- AIS: 5V alarm
- AIS: Loss of serial interface integrity
- AIS: Background noise above -77dBm

ACK messages

Can be generated by a minimum keypad and display (MKD) unit, chart plotter or other display device connected to the AIT1000 to acknowledge an alarm condition reported by the AIT1000.

ACK message format

```
$--ACK,xxx*hh <CR><LF>
```

Where

- xxx = unique alarm number

Antenna connections

There is a TNC female bulkhead connector located on the lower face of the AIT1000 housing. This TNC connector is where the GPS antenna must be connected to and the AIT1000 is supplied with a compact patch GPS antenna (with FME connector) and 7.5m FME-TNC connect cable.



As specified by the AIS Class B Transponder specification, all units must have a built-in GPS and cannot receive a position from other 3rd Party GPS units. However, it is possible to output the GPS and AIS data, from the AIT1000 for use on a dedicated chart plotter or PC software package.

Installation of the GPS antenna is critical for the performance of the built in GPS receiver which is used for timing of the transmitted time slots and for the supply of navigational information should the main navigational GPS fail. We strongly recommend that:

- The supplied GPS antenna and cable is used. Do not cut or splice the coax cable or lengthen the assembly
- The GPS antenna is mounted in an elevated position and free of shadow effect from the ship's superstructure. On a sail boat the pushpit rail or aft deck is an ideal location. The radar arch on a motor boat is ideal. If in doubt, make a temporary installation and use the aisPRO software to view the satellite signal strengths. The antenna can be thru deck mounted by drilling a 13mm clearance hole and using the supplied fixing nut to mount the antenna to the surface. Note that the nut can be reversed for thicker substrates. We recommend the use of a silicon sealant to ensure that the deck remains watertight. The supplied cable attaches to the antenna using the FME connector. The antenna could also be rail mounted with a suitable 3rd party or custom bracket.
- Fit the rubber boot supplied over the threaded assembly to prevent water ingress
- The GPS antenna has a free view through 360 degrees with a vertical angle of 5 to 90 degrees above the horizon.
- As the received GPS signal is very sensitive to noise and interference generated by other onboard transmitters, ensure that the GPS antenna is placed as far away as possible from radar, Inmarsat and Iridium transmitters and ensure the GPS antenna is free from direct view of the radar and the Inmarsat beam.
- It is also important that the MF/HF and other VHF transmitter antennas are kept as far away as possible from the GPS antenna. It is good practice never to install a GNSS antenna within a radius of 5 meters from these antennas.

The AIT1000 can also utilise other passive (ie non NMEA outputting) GPS antennas such as Garmin's GA29 fitted with the relevant TNC connector. The GPS antenna used must be of the active type (i.e. it should incorporate an LNA) and must be suitable for marine shipboard applications (index of protection, ruggedness, means of mounting, etc.). An antenna should be selected with a gain (in dB) depending on the length of cable between the antenna and the AIS unit; after subtraction of cable and connector losses a minimum total gain of 25 dB should be available at the AIT1000 unit GPS antenna connector. Please note that we cannot support the use of 3rd party antennas.

VHF Antenna

There is a BNC female bulkhead connector located on the lower face of the AIT1000 housing. The AIT1000 is NOT supplied with a dedicated VHF antenna, as many users connect their existing VHF antenna via the Digital Yacht SPL250 Splitter box (P/No. ZDIGSPL250).



For those customers who wish to fit a dedicated AIS tuned VHF antenna to the AIT1000, Digital Yacht can provide a suitable antenna as an optional accessory. The AIS Tuned Stub/Helical Antenna comes with an "L" shaped mounting bracket and 20m of cable (P/No. ZCOMH156A).

Even when mounted at deck level, this antenna should provide range in excess of 10NM and with some consideration given to the routing of the cable and location of the AIT1000 (during installation), can be used as a backup to the main VHF antenna in event of failure or dismasting.

IMPORTANT - Do not cut or splice this cable unless you are qualified to refit a BNC connector. The supplied connector is moulded on and cannot be refitted. The cable should not be shortened or lengthened.

If an alternative VHF antenna is to be employed for AIS use:

- Must be a dedicated antenna, i.e. not shared with any other VHF transmitter/receiver.
- Must be suitable for marine shipboard applications (index of protection, ruggedness, means of mounting, etc.)
- Should be omni-directional and vertically polarised with maximum gain of 3dBi and bandwidth sufficient to maintain VSWR <1.5 over the frequency range 156 – 163 MHz. As a minimum the 3dB bandwidth must cover the two AIS channels and the DSC Channel.
- Should be mounted with at least a two metre vertical separation distance from any other VHF antenna used for speech or DCS communication but see also the section “Radio Frequency Exposure Warning” below.

Warnings

VHF Antenna Connection

Connecting a badly mismatched VHF antenna, leaving the VHF antenna port disconnected, or shorting the VHF antenna port will activate the VSWR alarm, cause the unit to stop sending position reports and could cause damage to the transponder.

Radio Frequency Exposure

To meet the requirements for Radio Frequency Exposure it is necessary to install the VHF antenna correctly and operate the AIS equipment according to the instructions.

Electrical Connections

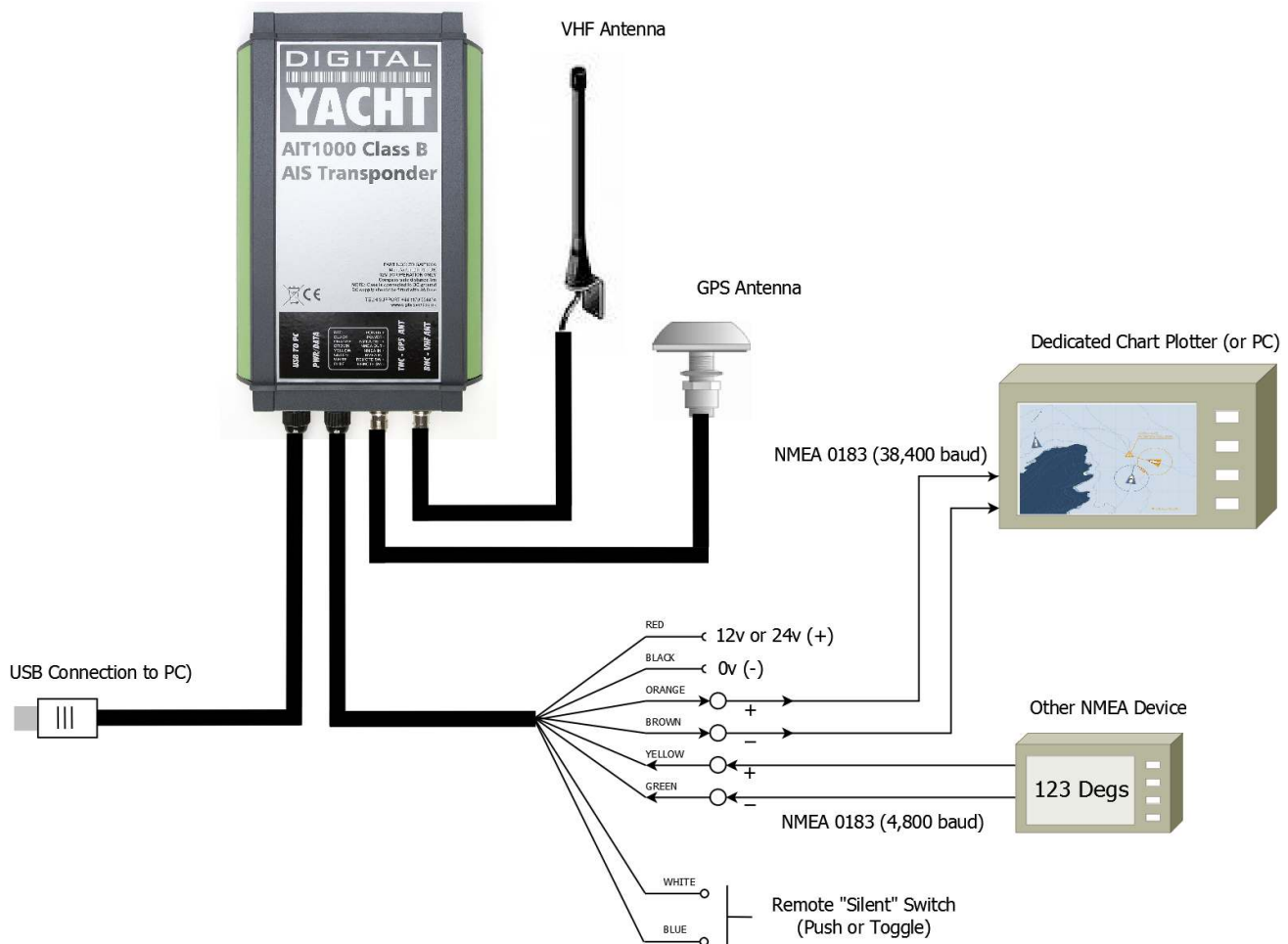

Notes:

1. Terminate and insulate all unused connections
2. Data is output on NMEA and USB ports simultaneously at 38,400 baud
3. Ensure plotter is set to receive NMEA data at 38400 baud
4. USB connection is seen as a virtual COM port on PC
5. In Device Manager check what COM Port the USB is mapped to i.e. COM3, COM4, etc.
6. Remote "Silent" Switch needs to be enabled in proAIS
7. If toggle switch is used; switch Closed = Silent and switch Open = Transmit
8. If push button switch is used; press and hold for 2 seconds to change mode
9. Only NMEA data received with **valid checksum** is re-transmitted on NMEA/USB outputs

Glossary

ACA	(AIS) Regional Assignment Channel Assignment Message
ACK	Acknowledgement
ACS	(AIS) Channel management information source messages
AFSK	Audio frequency-shift keying
ALR	(AIS) Alarm Message
A to N	Aid to Navigation
AIS	Automatic Identification System
BIIT	Built In Integrity Testing
BNC	Bayonet fitting type RF connector
CSTDMA	Carrier Sense Time Division Multiple Access
COG	Course over Ground
CR	Carriage Return
CS	Carrier Sense
CSTDMA	Carrier Sense TDMA
DC	Direct Current
DGNSS	Differential Global Navigation Satellite System
DSC	Digital Selective calling
GLONASS	Global Navigation Satellite System
GNSS	Global Navigation Satellite System
GMSK	Gaussian Minimum Shift Keying
GPS	Global Positioning Satellite / System
HF	High Frequency
IMO	International Maritime Organization
IEC	International Electrotechnical Commission
LED	Light Emitting Diode
LF	Line Feed
LNA	Low-noise amplifier
MF	Medium Frequency
MKD	Minimum Keypad and Display
MMSI	Maritime Mobile Service Identity
MPE	Maximum Permissible Exposure
NMEA	National Marine Electronics Association
PC	Personal Computer
PI	Presentation Interface

RF	Radio Frequency
RTCM	Radio Technical Commission for Maritime Services Commission
RX	Receive or Receiver
RFI	Radio frequency interference
SAR	Specific Absorption Rate
SMS	Short Message System
SOG	Speed over Ground
SRM	Safety Related Message
SRT	Software Radio Technology
TDMA	Time-division Multiple Access
TNC	Threaded type BNC connector
TX	Transmit or transmitter
UTC	Universal Time Co-ordinated
VDM	(AIS) VHF Data Link Messages
VDO	(AIS) VHF data link own vessel messages
VHF	Very High Frequency
VSWR	Voltage Standing Wave Ratio

User guide

AIT1000[©] proAIS Application

Note

proAIS is intended as a dealer application for programming and diagnostic testing of the AIT1000

It can also be used with an on board PC for real time data viewing

GENERAL WARNINGS

All marine Automatic Identification System (AIS) units utilise a satellite based system such as the Global Positioning Satellite (GPS) network or the Global Navigation Satellite System (GLONASS) network to determine position. The accuracy of these networks is variable and is affected by factors such as the antenna positioning, how many satellites are used to determine a position and how long satellite information has been received for. It is desirable wherever possible therefore to verify both your vessels AIS derived position data and other vessels AIS derived position data with visual or radar based observations.

The proAIS application is intended for use as an installation and configuration tool. **The application is not a navigation tool and should not be used as such.**

LICENSING

IMPORTANT: In most countries the operation of an AIS unit is included under the vessels marine VHF licence provisions. The vessel on to which the AIS unit is to be installed must therefore possess a current VHF radiotelephone licence which lists the AIS system and the vessel Call Sign and MMSI number. Please contact the relevant authority in your country for more information. In accordance with a policy of continual development and product improvement the AIT1000 hardware and software may be upgraded from time to time and future versions of the AIT1000 may therefore not correspond exactly with this manual. When necessary upgrades to the product will be accompanied by updates or addenda to this manual. Please take time to read this manual carefully and to understand its contents fully so that you can install and operate your AIS system correctly.

Information contained in this manual is liable to change without notice. Digital Yacht Ltd disclaims any liability for consequences arising from omissions or inaccuracies in this manual and any other documentation provided with this product.

DISCLAIMER

THIS SOFTWARE IS PROVIDED BY THE COPYRIGHT HOLDERS AND CONTRIBUTORS "AS IS" AND ANY EXPRESS OR IMPLIED WARRANTIES, INCLUDING, BUT NOT LIMITED TO, THE IMPLIED WARRANTIES OF MERCHANTABILITY AND FITNESS FOR A PARTICULAR PURPOSE ARE DISCLAIMED. IN NO EVENT SHALL THE COPYRIGHT OWNER OR CONTRIBUTORS BE LIABLE FOR ANY DIRECT, INDIRECT, INCIDENTAL, SPECIAL, EXEMPLARY, OR CONSEQUENTIAL DAMAGES (INCLUDING, BUT NOT LIMITED TO, PROCUREMENT OF SUBSTITUTE GOODS OR SERVICES; LOSS OF USE, DATA, OR PROFITS; OR BUSINESS INTERRUPTION) HOWEVER CAUSED AND ON ANY THEORY OF LIABILITY, WHETHER IN CONTRACT, STRICT LIABILITY, OR TORT (INCLUDING NEGLIGENCE OR OTHERWISE) ARISING IN ANY WAY OUT OF THE USE OF THIS SOFTWARE, EVEN IF ADVISED OF THE POSSIBILITY OF SUCH DAMAGE.

This software uses components and source code developed by other companies or groups.

Microsoft .Net Framework V2.0: Copyright © 2005 Microsoft Corporation

ZedGraph Graphing component dll (<http://zedgraph.org>): Provided under the GNU Lesser General Public License

All trademarks mentioned in this document are the property of their respective owners.

Copyright © 2008, Digital Yacht Ltd

Installation guide

Prerequisites

The proAIS application is designed to operate with Microsoft Windows 2000, XP, Vista and Windows 7. Recommended minimum system requirements are:

- Microsoft Windows XP SP2
- Display resolution of at least 1024 x 768
- At least one USB port

This software uses the Microsoft .Net Framework V2.0. The framework will be automatically installed during setup if not already present on the system.

Setup

1. Insert the installation CD and locate the Setup.exe file.
2. Double click the Setup.exe file to begin the installation.
3. Follow on screen prompts to install the .Net framework if required
4. When the security warning below is displayed, select 'Install'

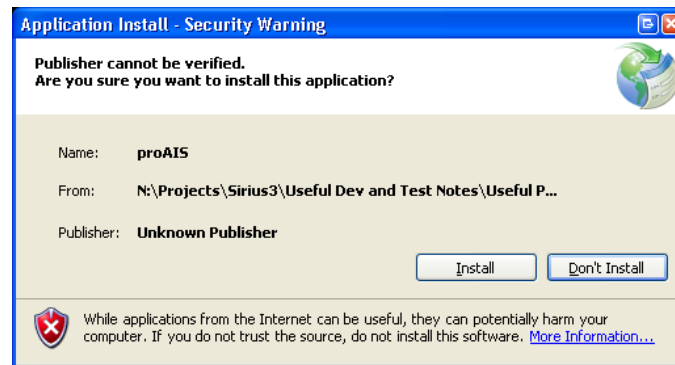

5. The application will install and launch automatically
6. A Start Menu folder and shortcut will be created with the name 'proAIS'. This short cut should be used to re-launch the application as required

Removal

The proAIS application can be removed at any time via the windows Control Panel 'Add or Remove Programs' tool.

User guide

AIS Connection

1. Launch the proAIS application by navigating to the 'proAIS' shortcut on the Start Menu.
2. The initial application screen will appear as shown below (exact screen display depends on version installed)

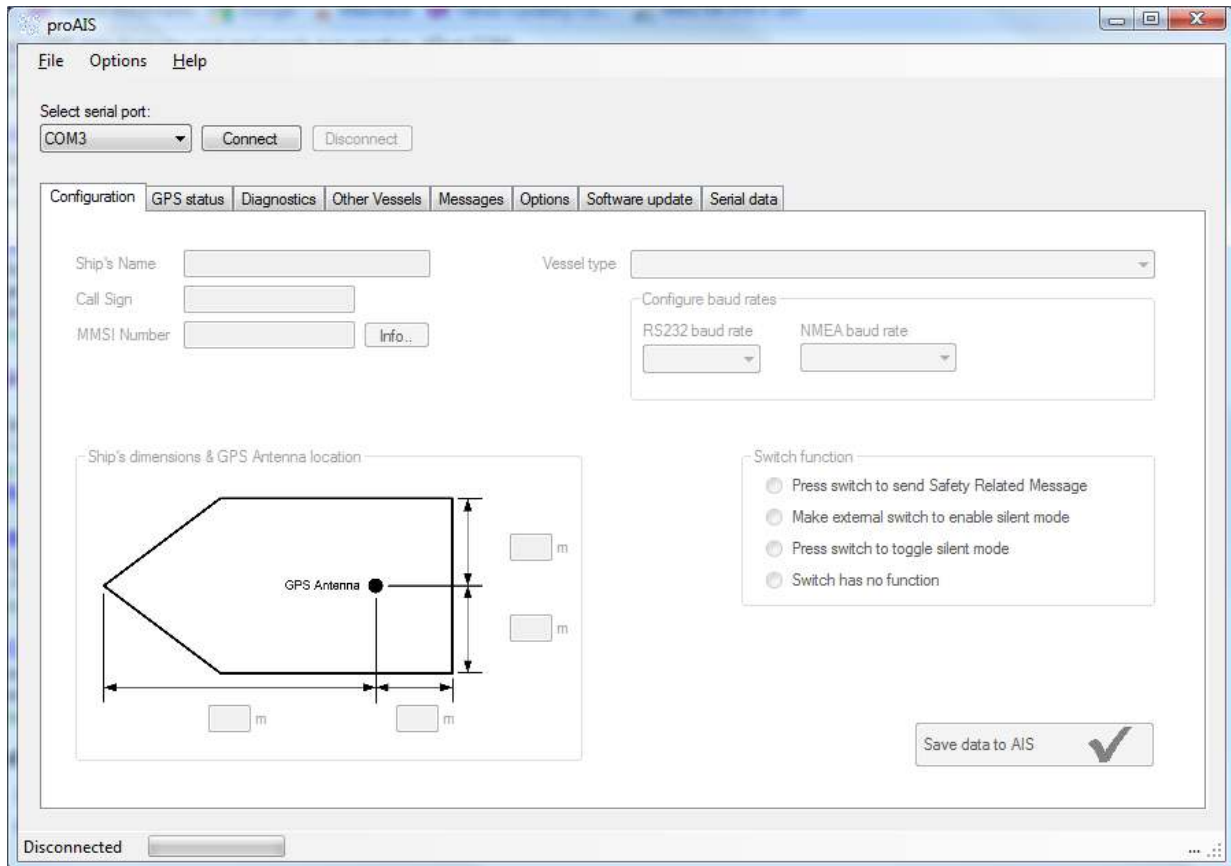

3. The application requires a serial connection to an AIT1000@ transponder. Connect the transponder to an available serial port. The application will not function correctly unless an AIT1000 is powered up and connected to a serial port
4. Select the serial port from the drop down menu, then click 'Connect':

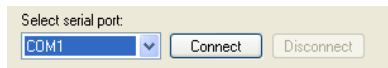

- Once a connection is established the application is ready to use. Connection status is indicated at the bottom left of the application window:

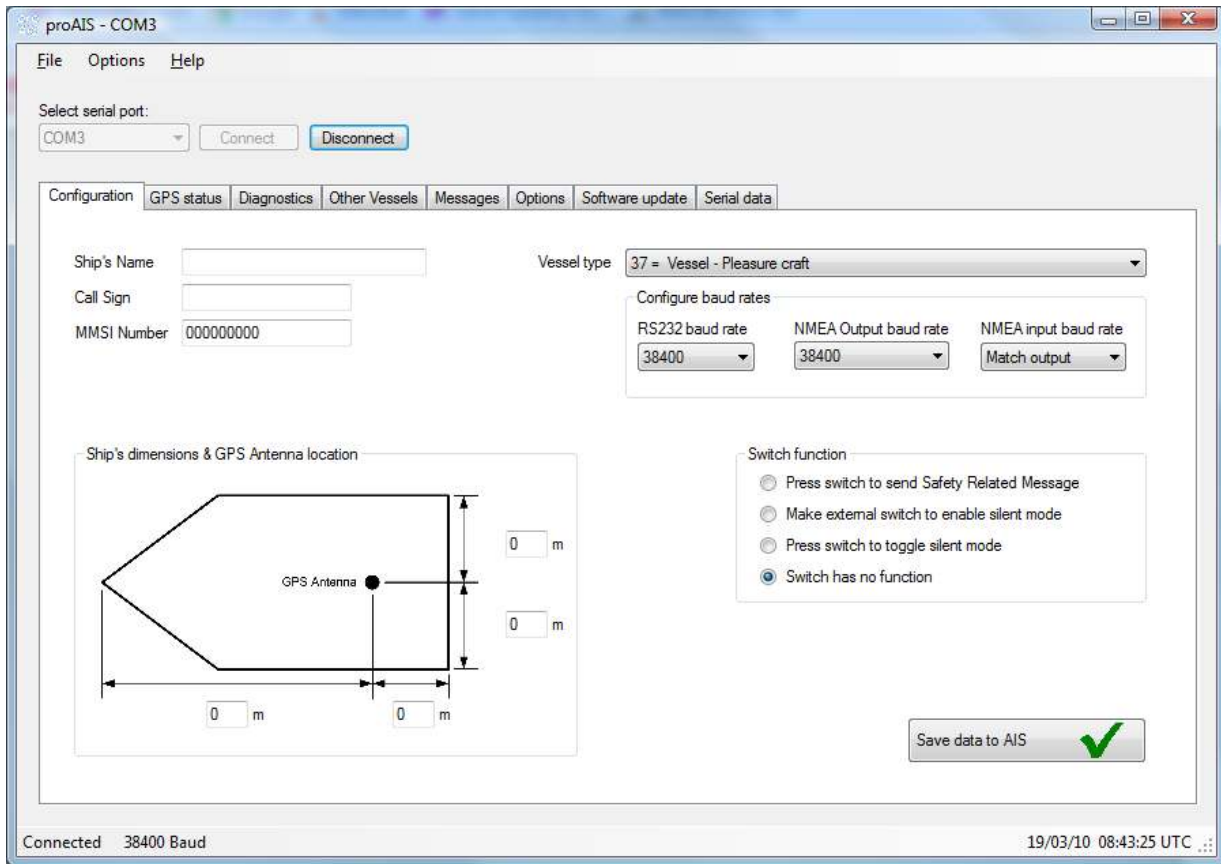

- The functions of proAIS are arranged in a series of tabs. Each tab contains information relating to a particular aspect of the connected AIS transponder. Depending on the version of proAIS installed not all tabs shown below may be visible.

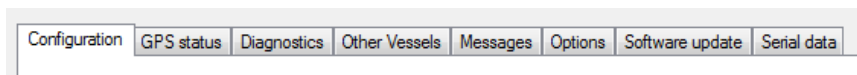

- Configuration tab
 - Displays the 'Static data' for the connected AIS transponder. This includes the vessel's name, call sign, MMSI number and other fixed information
 - Allows editing of the static data
- GPS Status tab
 - Shows the status of the internal GPS receiver, including position fix data and satellite signal strength graph
- Diagnostics tab
 - Shows the status of key system diagnostics. Used to troubleshoot installation of the transponder and verify correct operation.
- Other Vessels tab
 - Shows information about other vessels in the area received from the AIS transponder

- Messages tab
 - Displays safety related messages received from other AIS equipped vessels.
- Options tab
 - Provides access to software controlled features of the AIT1000 AIS transponder.
- Software update tab
 - Provides facilities to upgrade the transponder software from an update file.
- Serial Data tab
 - Shows the raw NMEA serial data being generated by the transponder. Provides a facility to log this data to a file for later analysis.
 - Allows NMEA commands to be sent to the transponder

Subsequent sections describe the functions of each tab in more detail.

Menu Bar

The menu bar provides basic program options.

Under the 'File' menu the 'Open log file' option allows playback of a log file previously recorded using proAIS. A log file can be recorded using the tools provided on the 'Serial Data' tab. During log file playback only data recorded in the log is available and most buttons in the application will be inoperative.

The 'Open log file' option is not available whilst a serial connection is made. Please disconnect from the AIS transponder to enable this option.

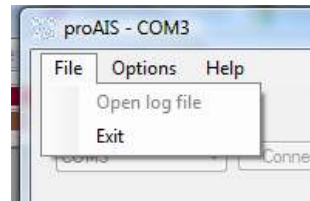

Under the 'Options' menu item checking 'Beep on AIS Transmission' will cause the PC to emit a sound every time the connected AIS unit transmits.

The 'Force connection' option is used for diagnosing connection issues and should be left unselected. This feature should be used under guidance from your technical support contact.

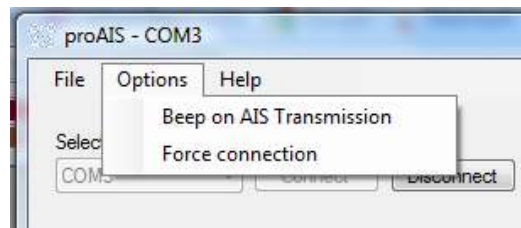

The Help -> About menu item displays the program splash screen and version information.

Static Data Tab

This tab shows the current configuration of the AIS transponder and allows the configuration to be programmed during installation into a vessel.

When an un-configured AIS transponder is connected for the first time the display will be similar to that shown below:

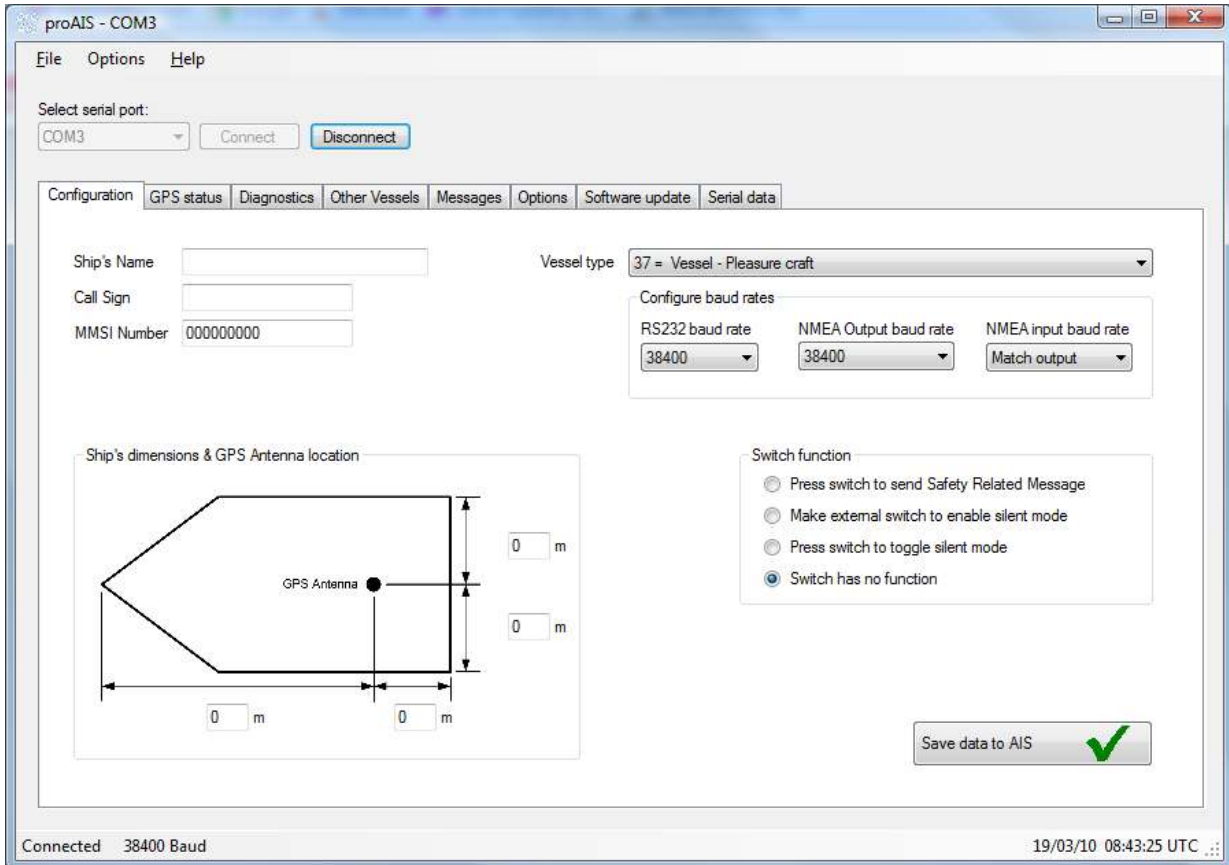

Configuring the transponder

To configure the transponder all of the data fields must be completed and saved to the AIS.



CAUTION:

For security reasons the MMSI of the vessel cannot be changed once programmed. Do not programme the MMSI unless you are certain you have the correct information. Please check the number entered carefully. If the MMSI programmed is incorrect the AIS transponder will need to be returned to the supplier for factory reset.

Configuring the transponder continued...

Enter the vessels information in the appropriate box:

- Ship's name - enter the name of the vessel (20 characters maximum)
- Call Sign - enter the vessel's radio call sign (7 characters maximum)
- MMSI number - enter the vessel's Maritime Mobile Service Identity number
- Enter the vessels dimensions as follows
 - Dimension A - distance from bows to GPS antenna location to the nearest meter
 - Dimension B - distance from the GPS antenna location to the stern to the nearest meter
 - Dimension C - distance from the port side to the GPS antenna location to the nearest meter
 - Dimension D - distance from the GPS antenna to the starboard side to the nearest meter
- Select the most appropriate vessel type from the drop down menu.
- An example showing typical data values is shown below;

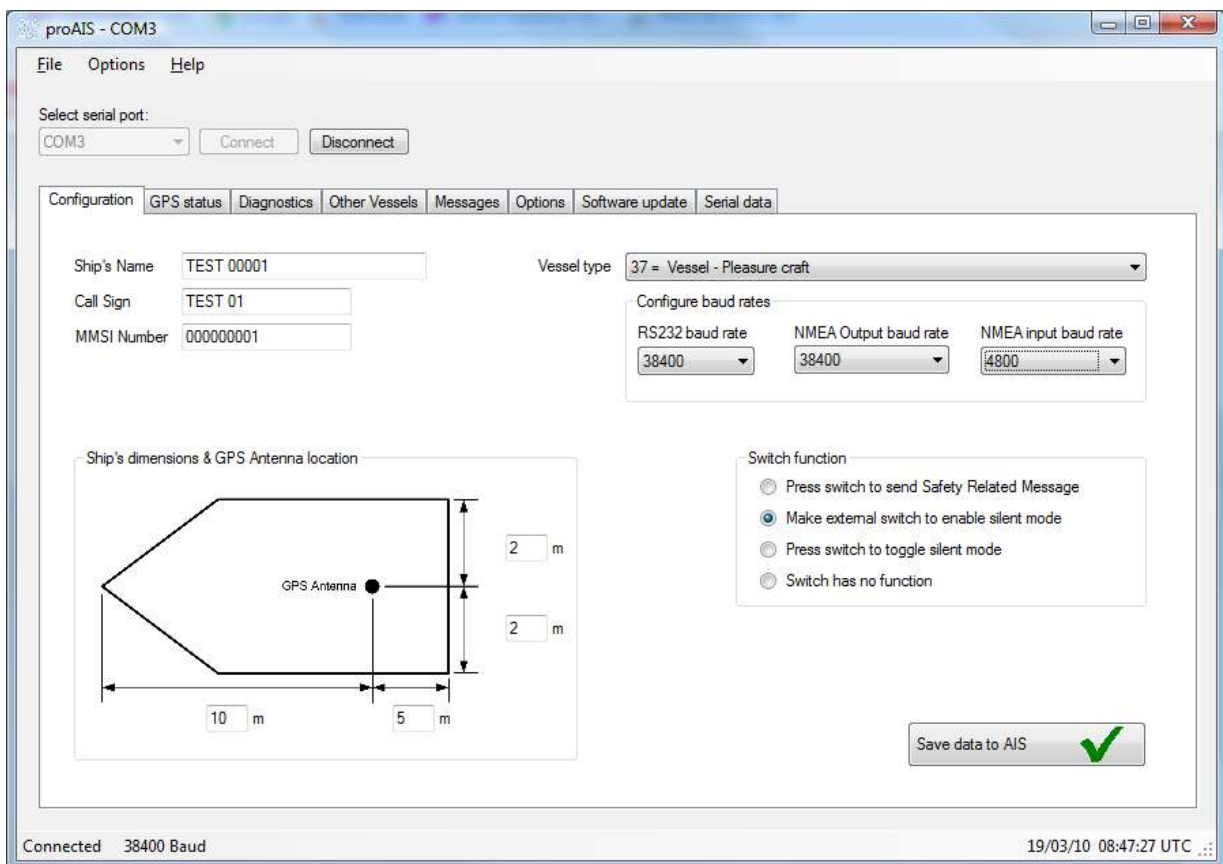
**CAUTION:**

If no MMSI is entered (MMSI is set to 000000000) then the AIS transponder will operate in receive only mode. The vessels own position will not be transmitted. An MMSI must be entered to allow the AIS transponder to transmit its own position to other vessels.

If you are connecting another NMEA0183 device to the AIT1000; such as a compass and wish this data to be multiplexed (merged) with the AIS data output by the AIT1000, then set the NMEA input baud rate to 4800 Baud. It is best to leave all other baud rates at 38,400 baud which is the standard high speed data rate used by AIS.

If you have connected a "Remote Switch" (push button or toggle) to the AIT1000, you will need to select the switch function you require before the remote switch can be used.

- Select the "Press switch to send Safety Related Message" option if you want to configure the unit to transmit an AIS "Safety Related Message" when the switch is pressed. The switch must be pressed for two seconds to initiate this message which is broadcast with the vessels MMSI and the text "MAYDAY MAYDAY". Please note this should not be considered as a primary means of distress call. Only works with a push button type switch.
- Select the "Make external switch to enable silent mode" option if you will use an external toggle switch for "Silent mode" control. Whilst the switch is closed the transmitter is disabled and other vessels will not receive your position via AIS. The receiver remains operational. The amber LED will illuminate to indicate the transmitter is disabled.
- Select the "Press switch to toggle silent mode" if you will use a push button switch to toggle "Silent mode" on and off. The switch must be held for two seconds to toggle the transmitter off or on. When the transmitter is disabled other vessels will not receive your position via AIS. The receiver remains operational. The amber LED will illuminate to indicate this transmitter is disabled.
- Select the "Switch has no function" option if you will not use a switch to control "Silent mode" or transmission of a Safety Related Message.

When you have entered all of the vessel's data click the 'Save static data to AIS' button to programme this configuration into the AIS transponder:

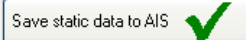

Save static data to AIS ✓

- A warning will be displayed asking you to verify the MMSI number. Please check the number displayed is correct before proceeding. If the number is incorrect click the 'No' button to cancel programming of the MMSI:



- Click the 'Yes' button if the MMSI is correct. If you select 'No' the static data will not be updated and you can correct the MMSI before proceeding.
- The static data tab will be updated to show the newly programmed vessel information. The MMSI number will be displayed with a grey background to indicate that it has been programmed and cannot be changed.

GPS Status tab

This tab shows the status of the internal GPS receiver. If the GPS receiver has position fix then the current position, speed and course are shown. A bar chart of satellite signal strength is also provided.



Satellite signal strength bars are shown in green for satellites that are currently being used for navigation. Blue signal strength bars are used to show satellites not currently being used for navigation. It is normal for the graph to display a combination of green and blue bars.

The information on this tab is intended for use during installation of the AIS transponder in order to verify connection of the GPS antenna.

Diagnostics tab

The diagnostics tab shows key status information from the AIS transponder. This information can be used to quickly verify that the transponder has been installed correctly and is operational.



AIS Transponder Status

- A tick next to the items in this area indicates correct operation.
- If a red cross is shown then some action may be required:
 - Transponder MMSI valid has a red cross - check the MMSI of the unit is configured by selecting the 'Static Data' tab and verifying that a valid MMSI has been entered. If the MMSI is 00000000 then it has not been programmed.
 - GPS position fix has a red cross - the GPS has not acquired a position fix. Please allow up to 5 minutes for a fix to be acquired. If the red cross is still present check the GPS antenna is correctly connected and has a clear view of the sky.
 - AIS has transmitted a position report has a red cross - the unit has not yet transmitted its position. Please allow up to 5 minutes after GPS fix has been acquired for the green tick to appear. If the red cross is still present after this time please refer to the active alarms section below. The AIS will not transmit unless it has acquired GPS fix and has a valid MMSI programmed
 - AIS has received a position report - a position report from another vessel has been received. If there is no other AIS equipped vessel in the area the red cross will remain against this item. If other AIS equipped vessels are present and the red cross remains please check the VHF antenna connections.

AIS Transponder Active Alarms

Any active alarm messages generated by the AIS unit are shown here

- Note that alarms may take up to 1 minute to clear from this display once their source has been corrected
- It is normal for GPS related alarms to be displayed when the AIS is first switched on. These alarms will clear once GPS position fix is acquired.
- Please refer to the troubleshooting section for a description of each alarm message

AIS Transponder Information

This section shows technical information about the connected AIS transponder including software and firmware version information. Depending on the AIS software version the ability to display the GPS firmware version may not be present. If shown clicking the 'Get version' button will retrieve the GPS firmware version. Please note that this operation may result in a temporary loss of GPS fix.

LED Status

This section mirrors the LED display on the front of the AIS transponder and is useful when the unit is installed in a location where the physical LEDs are not easily visible.

Internal Data

This section provides internal diagnostics data from your AIS transponder. Your dealer may request this information if diagnosing any problems with your installation.

Supply voltage is a very important factor in the correct operation of the AIT1000, this value should always be above 10.8v otherwise the AIT1000 will start transmitting alarm messages as correct operation cannot be guaranteed. If this value is low, ensure that your 12v supply is producing enough voltage and that there is not excessive voltage drop in the power cables.

The RRSI (Received Signal Strength Indicator) and TX Power values are good indicators of how well your antenna is receiving and sending data.

- RRSI values should be between 20 and 100 - if they are continually lower than this there may be a problem with the antenna or AIT1000 receiver
- TX Forward Power should be as high as possible, typically between 130-150
- TX Reverse Power should be as low as possible, typically between 10-30

Statistics

This section shows the number of AIS messages received and transmitted on each of the AIS channels. You can use this information to verify that the transponder is successfully receiving and transmitting data when other AIS equipped vessels are in range.

Software update tab

This tab provides the facility to update the AIS transponder's internal software.

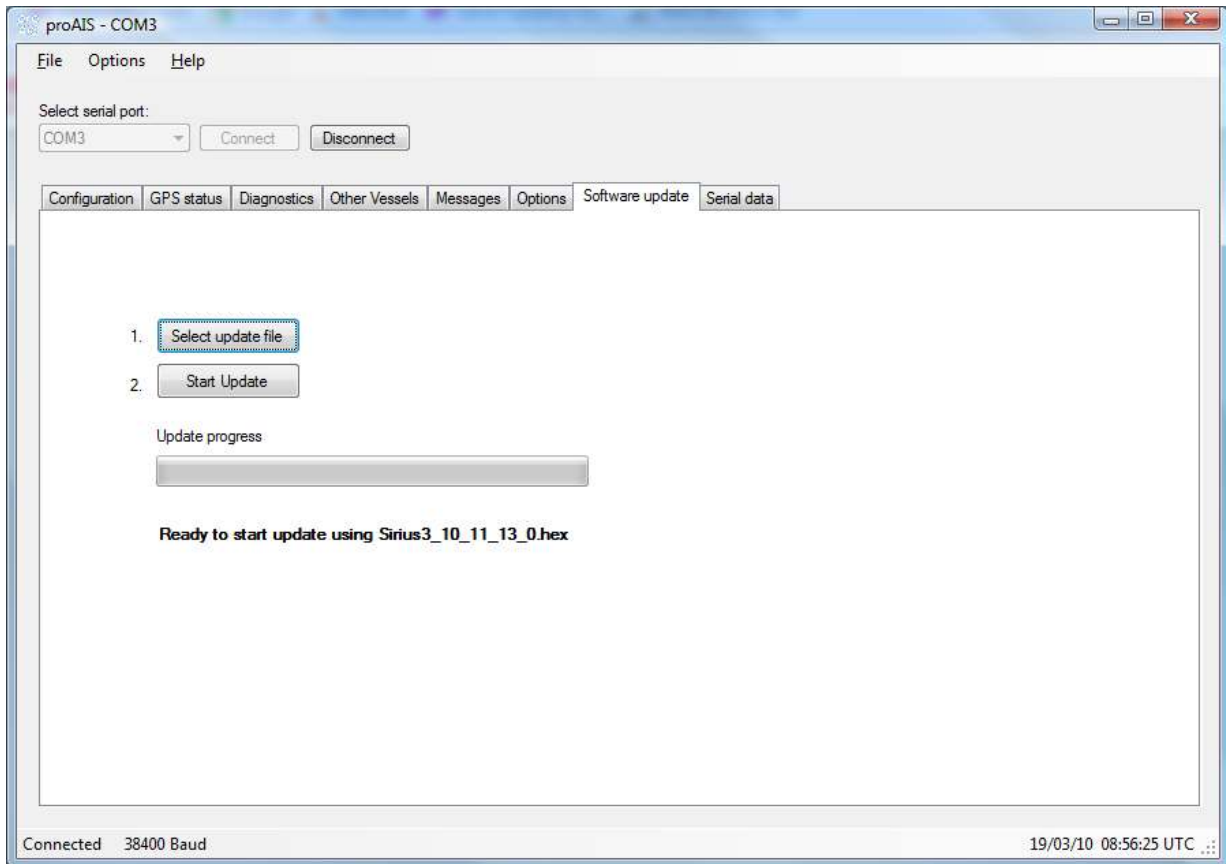

CAUTION:

Only perform a software update using an update file intended for use with the AIT1000© product.

Do not interrupt the power to the unit or disconnect from the PC during the update process unless instructed to do so by the proAIS application.

1. Click the 'Select update file' button and navigate to the update file. This will have the extension .hex
2. Click the 'Start update button'
3. Follow the instructions provided underneath the update progress bar.
4. Depending on the AIS software version you may be requested to power cycle the unit at two points in the process. Turn the power supply to the AIS off and back on again at these requests. Do not disconnect the serial connection to the PC.
5. Once the 'Update completed' is displayed the AIS is ready for use
6. Please verify the information shown on the static data tab is correct after any software update.

Other vessels tab

This tab shows information received from other AIS equipped vessels in the area.

- The MMSI of each vessel is shown.
 - Vessels equipped with Class A AIS have the MMSI displayed in black text.
 - Vessels equipped with Class B AIS have the MMSI shown in blue text
- The name and call sign of each vessel is shown
 - Due to the way AIS operates this information may take some time to appear
- The speed in knots, course in degrees, decimal latitude and longitude are shown for each vessel
- The approximate distance to each vessel is shown when the connected unit has a GPS fix. Please note that this is an **approximate** distance for indication only.
- The class of the AIS equipment on each vessel is displayed as A or B
- Columns can be sorted into ascending or descending order by clicking on the column heading.

The screenshot shows the 'proAIS - COM3' software window. The 'Other Vessels' tab is active, displaying a table with the following columns: MMSI, Name, Call Sign, Speed (kn), Course, Latitude, Longitude, Range (nm), and Bearing(°). The table contains 25 rows of vessel data. The status bar at the bottom indicates 'Connected 38400 Baud' and the time '19/03/10 08:53:22 UTC'.

MMSI	Name	Call Sign	Speed (kn)	Course	Latitude	Longitude	Range (nm)	Bearing(°)
235064777	WIGHT SUN	2BBW9	0	90.6	50°42.411	-1°30.036	16.52	237
235031618	ST FAITH	MMDA5	0	293	50°44.07	-1°12.7902	7.84	202
235899934	RAYBASE 06		0	0	50°50.8038	-1°5.2686	1.84	106
236039000	BALTIC SKIPPER	ZDFD5	13.6	75.1	50°31.3902	-1°5.3166	20.03	175
235031619	ST HELEN	GDBB	11.4	235	50°45.5298	-1°9.1098	5.82	186
235024149	SPIRIT OF PORTSMOUTH	MHBV5	0	262.1	50°47.8206	-1°6.5622	3.62	165
235032402	HUMBER ENERGY	MDCU5	0.1	339	50°47.1012	-1°17.1846	7.14	234
235007472	FREEDOM 90	MLMJ9	12.7	51	50°47.079	-1°6.0138	4.43	163
235039868			0.1	157	50°43.98	-1°9.5298	7.4	187
235275973	PILOT V/L HAMSTEAD	MCTH3	0	12.6	50°47.4732	-1°6.8562	3.92	169
227023100	MONT SAINT MICHEL	FNMT	10.7	181	50°45.9366	-1°5.3712	5.65	162
235064784	WIGHT LIGHT	2BBX5	4.5	114.6	50°45.1362	-1°31.4388	16.03	247
235061621	SD SOLENT RACER	2AON9	11.7	328	50°46.71	-1°6.06	4.78	164
235069875	WIGHT RYDER I	2BWG5	23.2	44.9	50°45.2118	-1°8.166	6.11	180
235069877	WIGHT RYDER II	2BWG7	0.1	242.5	Not available	Not available	0	0
235013375	PILOT V/L HASLAR	MCLN6	16.8	207.7	50°45.033	-1°4.7748	6.63	162
308835000	PRIDE OF BILBAO	C6MF8	0.2	61	50°48.6702	-1°5.7198	3.04	150
235073846	PORT OF SPAIN	2CLP9	0	0	50°48.303	-1°5.9994	3.29	156
232002939	SD POWERFUL	GAAG	0	342	50°48.5994	-1°6.339	2.92	158
235066825	SD SOLENT SPIRIT	2AON8	0	356	50°48.03	-1°6.6198	3.41	164
308094000	COMMODORE CLIPPER	C6QQ3	0	306	50°48.7452	-1°5.6712	2.99	149

Options tab

The Options tab provides access to software controlled features of the AIT1000 transponder. Depending on the AIS software version the following commands may be available:

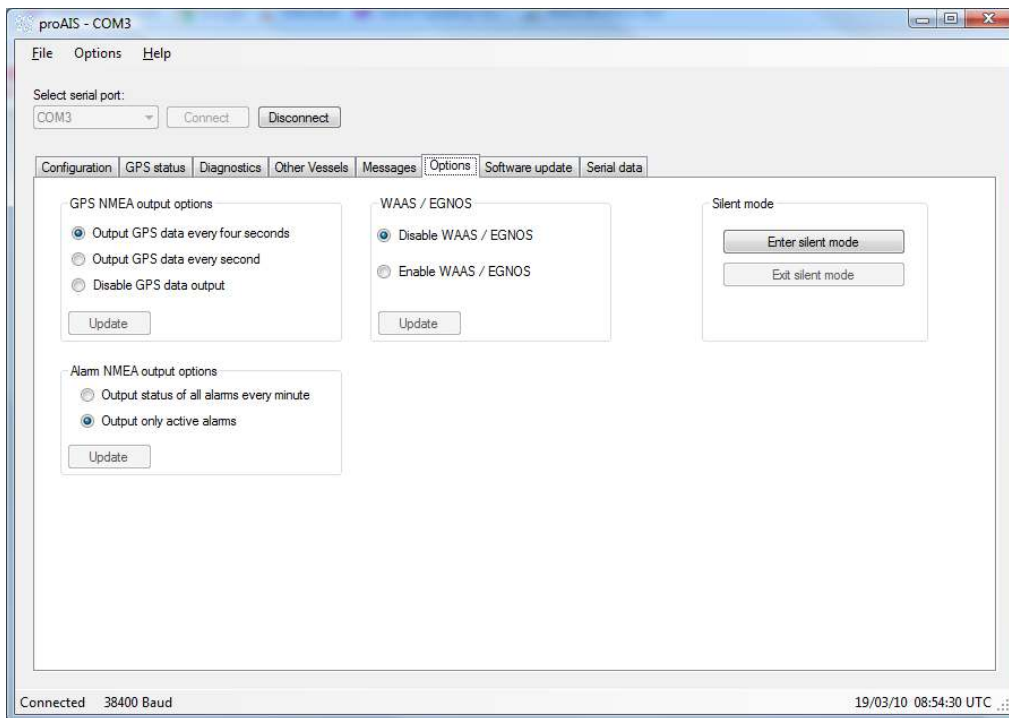

- Silent mode
 - Buttons to enter / exit silent mode. In Silent mode the transmitter is disabled and no position reports are transmitted by the unit. Other AIS users will be unaware of your position in this mode so it should be used with caution and only where allowed by local regulations.
- GPS output options
 - By default the AIS transponder will output its current GPS position data every four seconds via the USB and NMEA serial interfaces. This information is sent using the GPRMC sentence and can be used to provide your vessels GPS position to a chart plotter connected to the unit. A higher position update rate (once per second) is available as an option and will result in a more accurate display of your vessels position, speed and course on a connected chart plotter. To use this option select the "Output GPS data every second" option and click 'Update'.
- WAAS / EGNOS
 - To gain the benefit of improved GPS position accuracy by using the WAAS / EGNOS differential GPS services, enable this feature and click 'Update'.
- Alarm output options
 - By default the AIS transponder will only output the status of active alarms using AIALR sentences. The unit can optionally be configured to output the status of all alarms every minute using the radio buttons. The 'Update' button should be clicked to send new settings to the AIS transponder.

Troubleshooting guide

Problem	Possible cause	Solution
General		
No AIS is detected	The AIS is not connected to the serial port selected from the drop down menu	Check the number of the serial port the AIS is connected to and retry
	The AIS is not powered	Check that the power supply is connected and switched on
	The serial cable is damaged or faulty	Try an alternative serial cable
Cannot communicate with unit	The AIS is not connected to the serial port selected from the drop down menu	Check the number of the serial port the AIS is connected to and retry
	The Serial cable is damaged or faulty	Try an alternative serial cable
Static Data tab		
No static data is displayed	The unit has not yet been configured	Follow instructions in the Static data section to configure the unit
The MMSI can not be changed	The MMSI has already been programmed	The MMSI can only be programmed once. If it is incorrect please contact your dealer.
The static data is incorrect	Data was entered incorrectly	Re-enter the static data and save to the AIS. The MMSI cannot be updated.
GPS tab		
No GPS position information is displayed (or graph shows only blue bars)	The unit has not acquired GPS fix	Check the GPS antenna connections and power cycle the AIS unit. Check the GPS antenna location and make sure it's view of the sky is not obstructed Check the AIS installation manual against the specification of your GPS antenna
	The GPS antenna is not correctly connected	
	The GPS antenna does not have a clear view of the sky	
	GPS antenna is unsuitable for use with AIS	
Diagnostics tab		
Red cross against a status item	Unit configuration or antenna connections	See Diagnostics tab section of this user guide for advice on each item
Active alarm shown:	The unit has not acquired GPS fix	Wait at least five minutes for the unit to acquire GPS position fix

Problem	Possible cause	Solution
Position sensor fault OR SOG data fault OR COG data fault OR		Follow troubleshooting guide for GPS tab
Active alarm shown: VHF Antenna VSWR fault	The VHF antenna is not connected or is not suitable for use with the AIS	Check the VHF antenna connections. Check the AIS installation manual against the specification of your VHF antenna
Active alarm shown: 12V Power supply fault	The power supply to the AIS is outside the specified range.	Check the power supply voltage to the AIS against that specified in the installation manual.
Active alarm shown: Channel A Noise fault OR Channel B Noise fault	The AIS cannot transmit because the background noise level is too high	Check the VHF antenna connections. Check the AIS installation manual against the specification of your VHF antenna. In very busy shipping channels this alarm may appear temporarily. This is normal operation for Class B AIS.
Active alarm shown with message not listed here	The VHF antenna is not connected or is not suitable for use with the AIS. AIS has an internal fault.	Check the VHF antenna connections. Check the AIS installation manual against the specification of your VHF antenna. Please contact your dealer.

For more information about the latest AIT1000 software, Tech
Notes and FAQs, please visit our website;

www.digitalyacht.co.uk